

User Guide

ORIGINAL

www.glo-toob.com

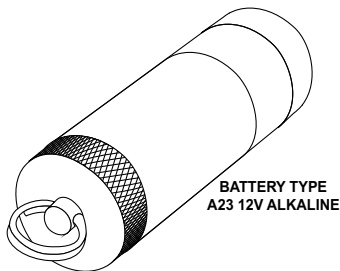

High intensity waterproof light source

KEY FEATURES

- Waterproof to 3,500 meters (11,500 feet)
* ONLY WHEN SCUBA CAP IS USED *
- Single Mode 100% power
- Powered by inexpensive alkaline battery
- Virtually indestructible
- Battery life Approx. 30 hours

Push Button Splashproof Cap

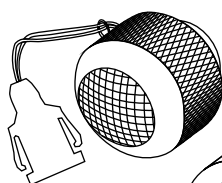

GLO-TOOB Body

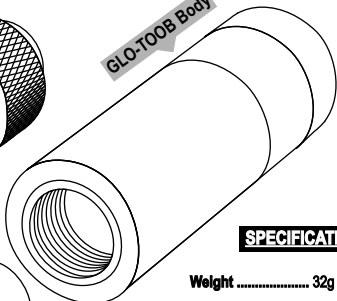

A23 12V Alkaline Battery

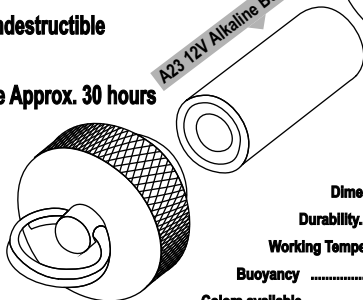

Twist Waterproof Cap





SPECIFICATIONS

Weight	32g (1.3 oz)
Shape	Cylindrical
Viewing Angle.....	360°
Light Source	High Bright LED's
LED Life	Approx. 100,00 hrs
Battery Life	Approx. 30 hrs
Dimensions	67mm x 19mm (2.63in x 0.75in)
Durability.....	High-impact resistant
Working Temperature	-20°C to +80°C (-4°F to 176°F)
Buoyancy	Negative
Colors available	Red, Amber, Blue, Green, White

The simple trusted ORIGINAL

CAP SPECIFICATIONS

All caps only Available with
3 Cap Accessories pack

Only Available with 3 Cap Accessories pack  Thread Protector Cover	 Twist On/Off Waterproof Cap	 Push Button Splashproof Lanyard Cap	Only Available with 3 Cap Accessories pack  Solid On SCUBA Cap
Aircraft grade aluminum with hardcoat anodizing	Yes	Yes	Yes
Strength	High impact	Low impact	High impact
Attachment type	Stainless Steel split-ring	Detachable Lanyard & Clip	Stainless Steel split-ring
Switch type	Twist ON / OFF	Push button	No (Solid contact type)
Waterproof	3,500 meters (11,500 feet)	Splashproof	3,500 meters (11,500 feet)
Working temperature	-20°C to +80°C (-4°F to 176°F)	-20°C to +80°C (-4°F to 176°F)	-20°C to +80°C (-4°F to 176°F)
Seal type	2 x Nitrile O-rings	1 x Nitrile O-ring	1 x Nitrile O-ring

Twist On/Off Waterproof Cap

The Twist ON/OFF Waterproof Cap allows the GLO-TOOB to be switched ON or OFF underwater at any depth. **CAUTION: TAKE CARE TO ONLY TURN THE RING PIN WHILE UNDERWATER SO AS NOT TO LOOSEN THE CAP AND CAUSE ACCIDENTAL FLOODING.** This cap is equipped with a STAINLESS STEEL ATTACHMENT RING.

Push Button Splashproof Lanyard Cap

The Push Button Splashproof Cap is designed for above water use only. Simply depress the rubber cap to turn ON or OFF to cycle through the multi-mode functions. This cap is equipped with a STRONG 40cm(15.7") DETACHABLE LANYARD.

Solid On SCUBA Cap

The Solid On SCUBA Cap is designed for safe SCUBA diving. This cap ensures that the unit works without the use of a switch or button. Once ON always ON. This eliminates the risk of accidental flooding underwater. This cap is equipped with a LARGE STAINLESS STEEL ATTACHMENT RING.

When the cap is not in use, use the protector cover to ensure no water comes in contact with the conductive threads.

All caps only Available with
3 Cap Accessories pack

Care and Maintenance

In order to prolong the life of your GLO-TOOB, it is recommended that preventive maintenance is performed on a periodic basis as follows:

1. Exposure to Saltwater

After saltwater exposure it is highly recommended that the GLO-TOOB is rinsed in fresh water and then dried before opening. This will reduce the possibility of corrosion and extend the life of your GLO-TOOB.

2. Contact surfaces

All GLO-TOOB caps have conductive aluminum threads to hold the caps in place as well as to conduct power. Should the threads come into contact with water, an aluminum oxide layer will be formed around the threads possibly rendering the contact area faulty. For this reason please make sure the threads stay dry and clean. Use the universal protector cover to keep threads dry and clean when not in use around wet environments.

3. Washer (seal)

The washer on the inside of the caps must be checked each time before the GLO-TOOB is submerged in water. If the washer is cracked or cut, replace the washer immediately. Also check for general cleanliness of the washer to ensure that particles do not affect the watertight seal.

4. Battery

Leaking batteries can corrode the inside of your GLO-TOOB. It is therefore recommended that you open your GLO-TOOB once a month and check the battery for signs of leakage and / or corrosion. It is also recommended that you remove the batteries from your GLO-TOOB and store them separately if you use your GLO-TOOB infrequently.

LIMITED LIFETIME WARRANTY

The manufactures of GLO-TOOB warrants each GLO-TOOB to be free from defects in material and workmanship. Under this warranty the manufactures of GLO-TOOB obligation is limited to replacing or repairing any GLO-TOOB returned to us and found to be defective in either material or workmanship.

This warranty excludes the following: 1. Battery Leakage (determine the brand of the battery and follow that battery manufacture's instructions on how to make a damage claim). 2. LED Burnout. 3. Failure of or damage to GLO-TOOB due to misuse and/or lack of maintenance. 4. Accidental flooding of the GLO-TOOB by exposing the battery chamber to moisture/water.

For WARRANTY INFORMATION or REPAIR INSTRUCTIONS, please visit our website at:

www.glo-toob.com